

Order #:
Allura-10 160x192-SMD
120V / 1850W / 15.4A / 269LBS / Per Face
208V / 1850W / 8.9A / 269LBS / Per Face



Support@thinksign.com
www.ThinkSign.com

- NOTES:
 1.DISPLAY IS REAR VENTILATED, DO NOT BLOCK UP VENTILATORS.
 2.FRONT ACCESS FOR SERVICE.
 3.THINKSIGN IS NOT RESPONSIBLE FOR THE MAIN ELECTRICAL DISCONNECT.
 4.THINKSIGN IS NOT RESPONSIBLE FOR THE MOUNTING HARDWARE OR THE INTEGRITY OF THE STRUCTURE THE DISPLAY IS MOUNTED TO.

Please Keep For Service!

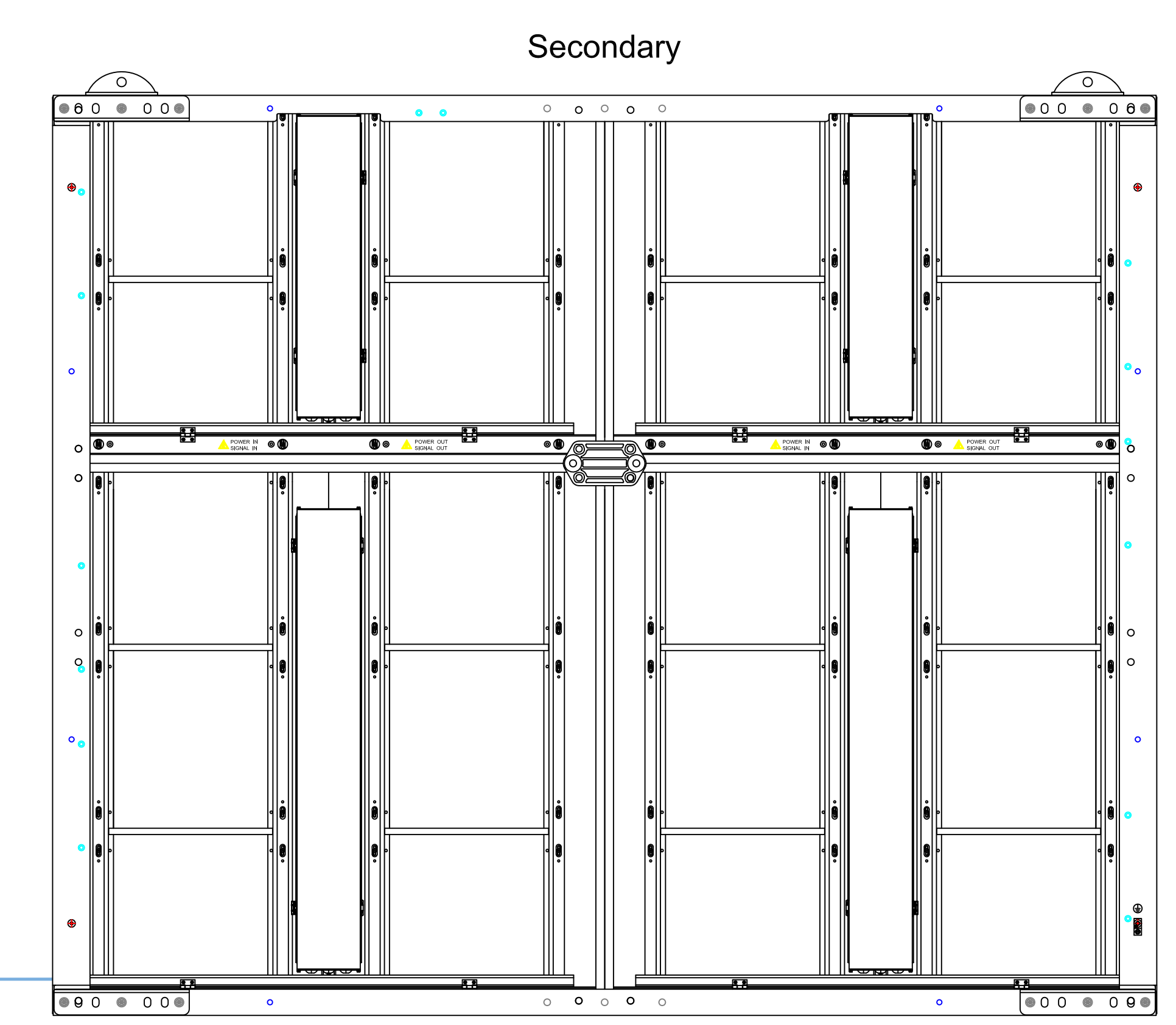
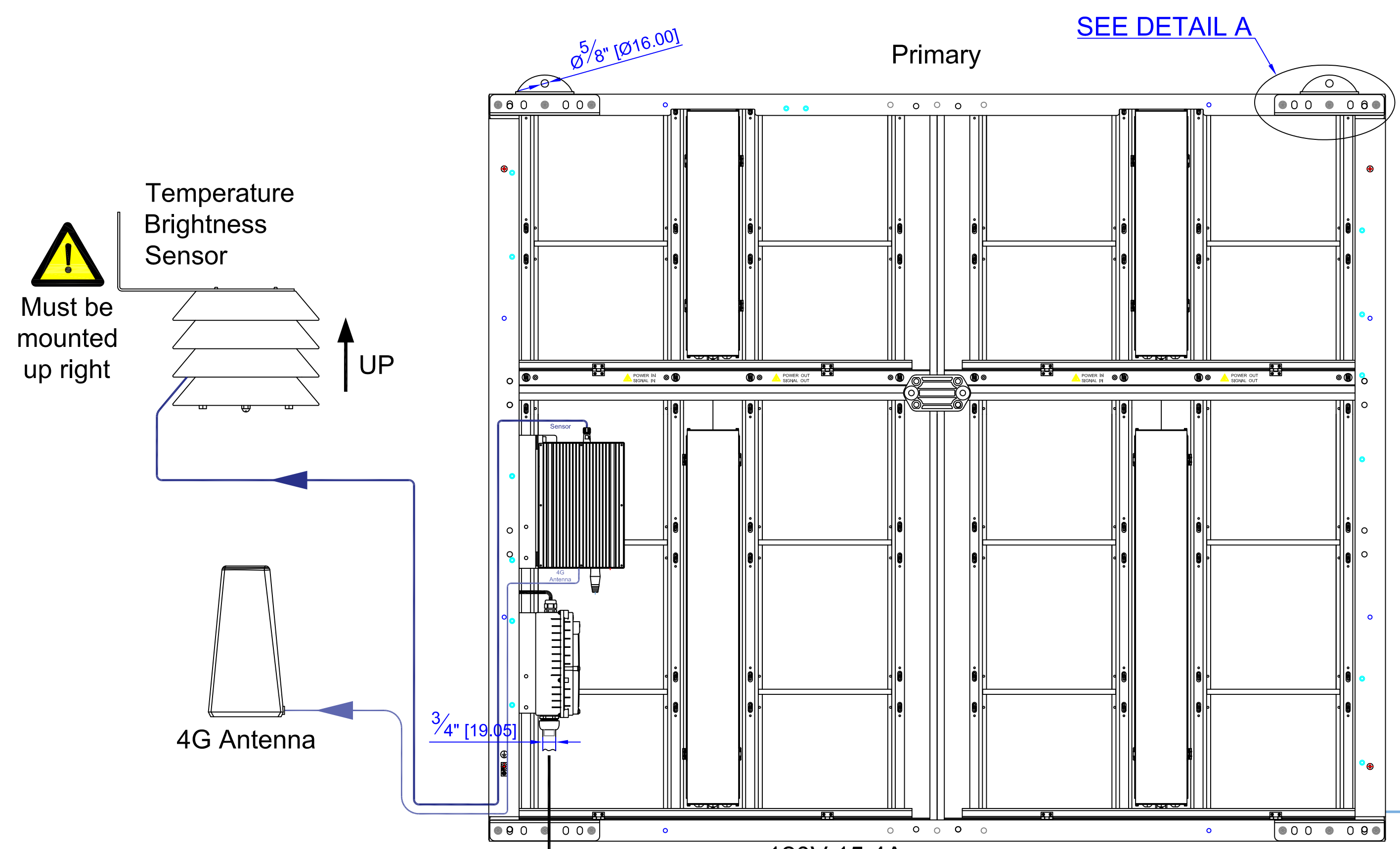
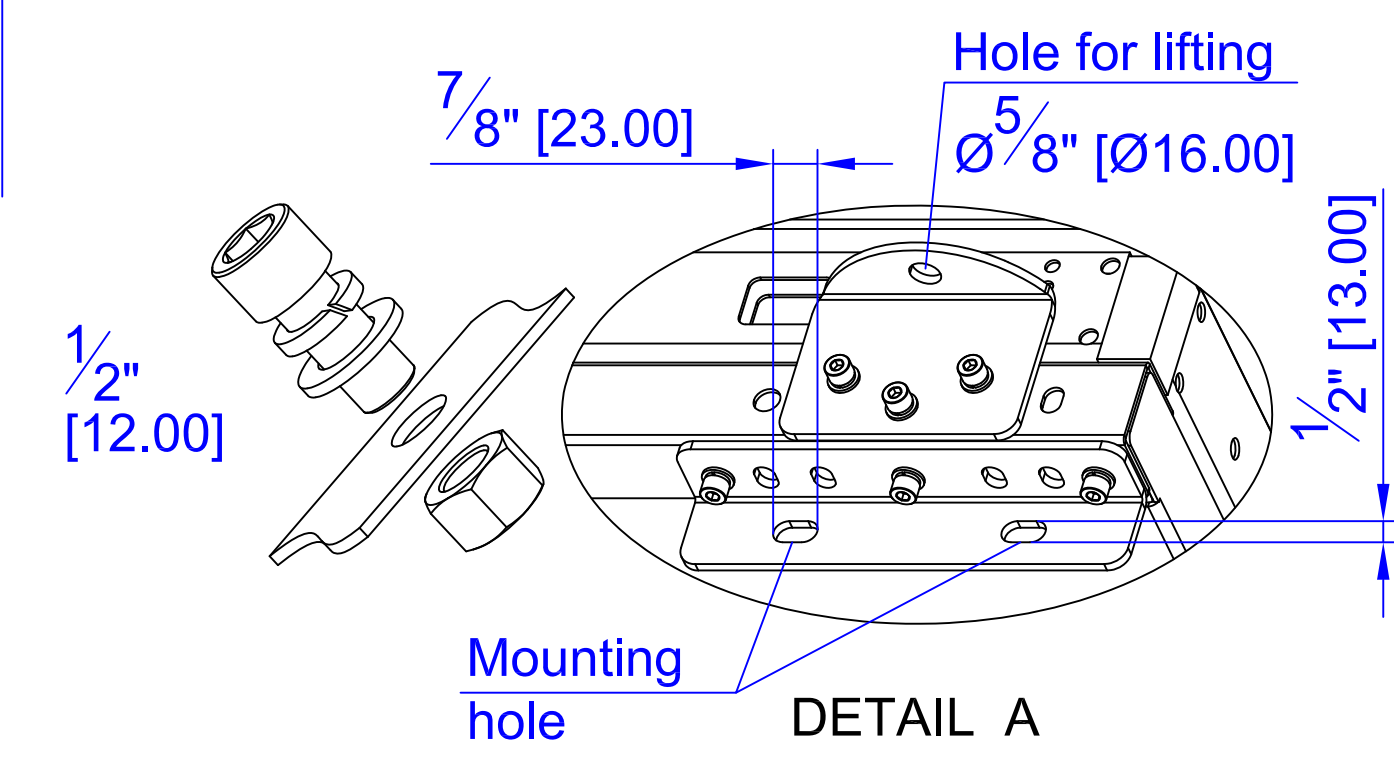
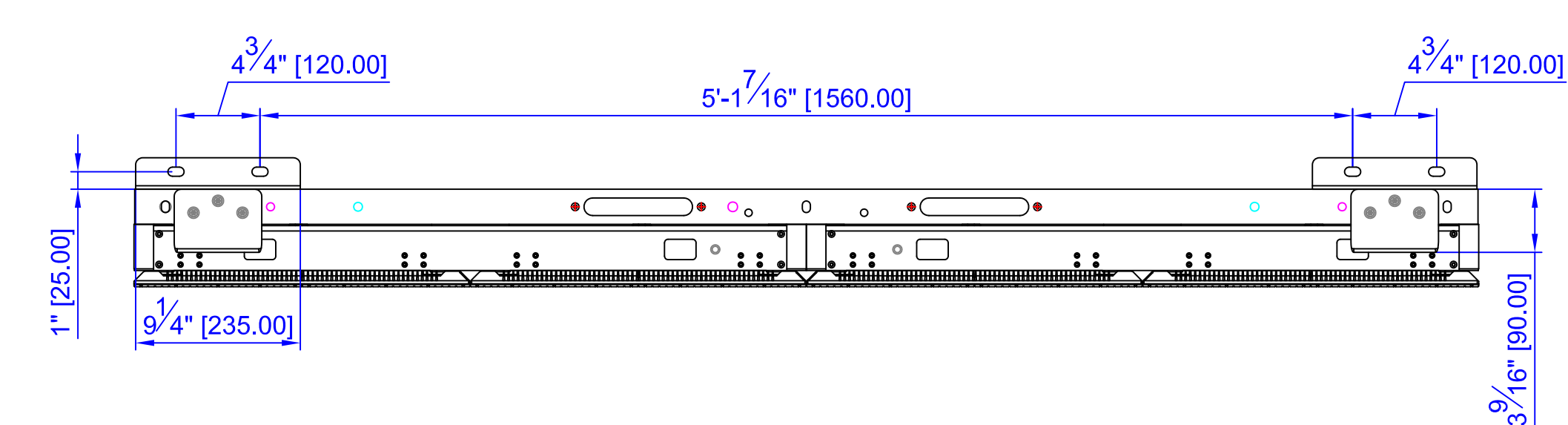
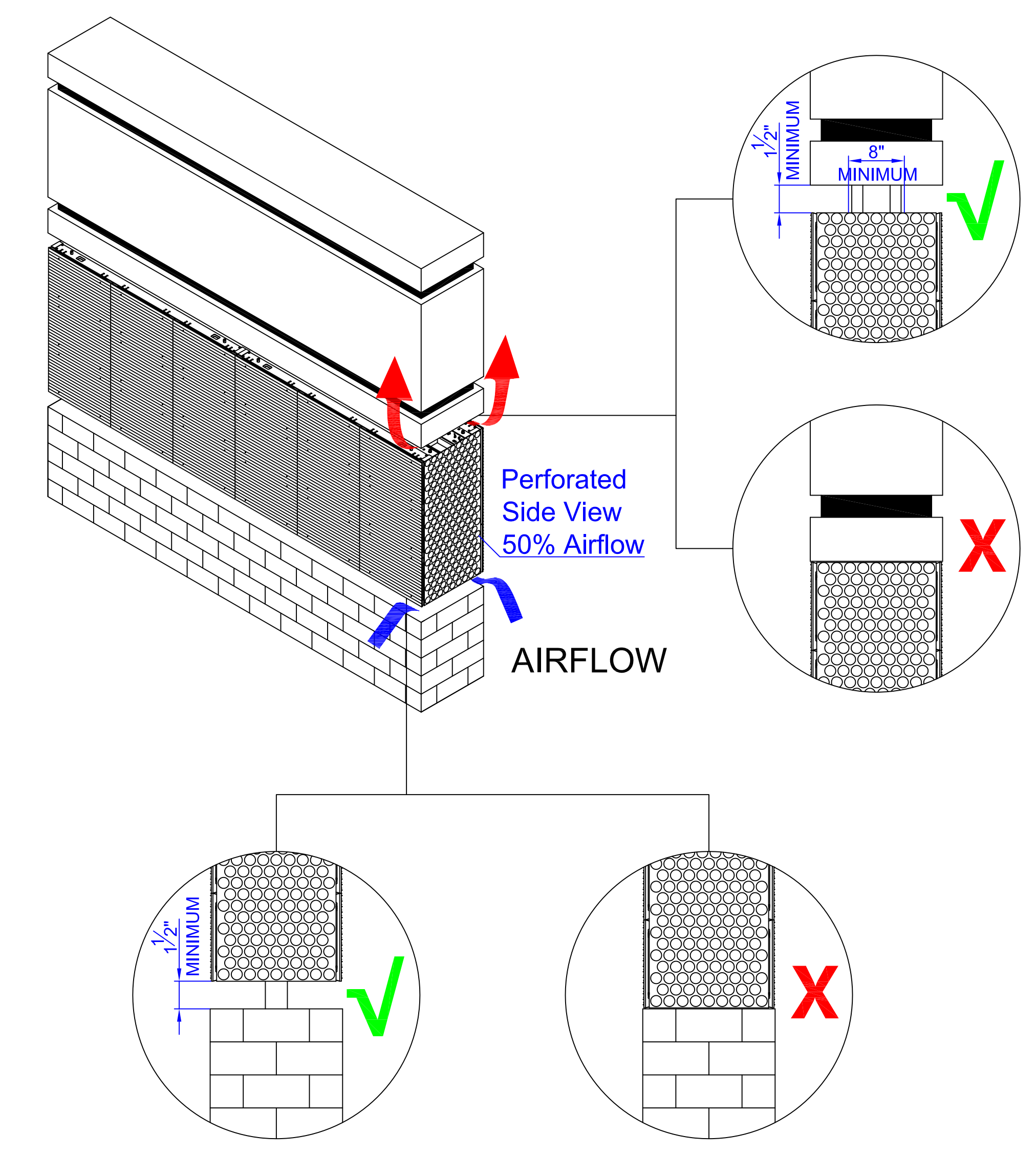
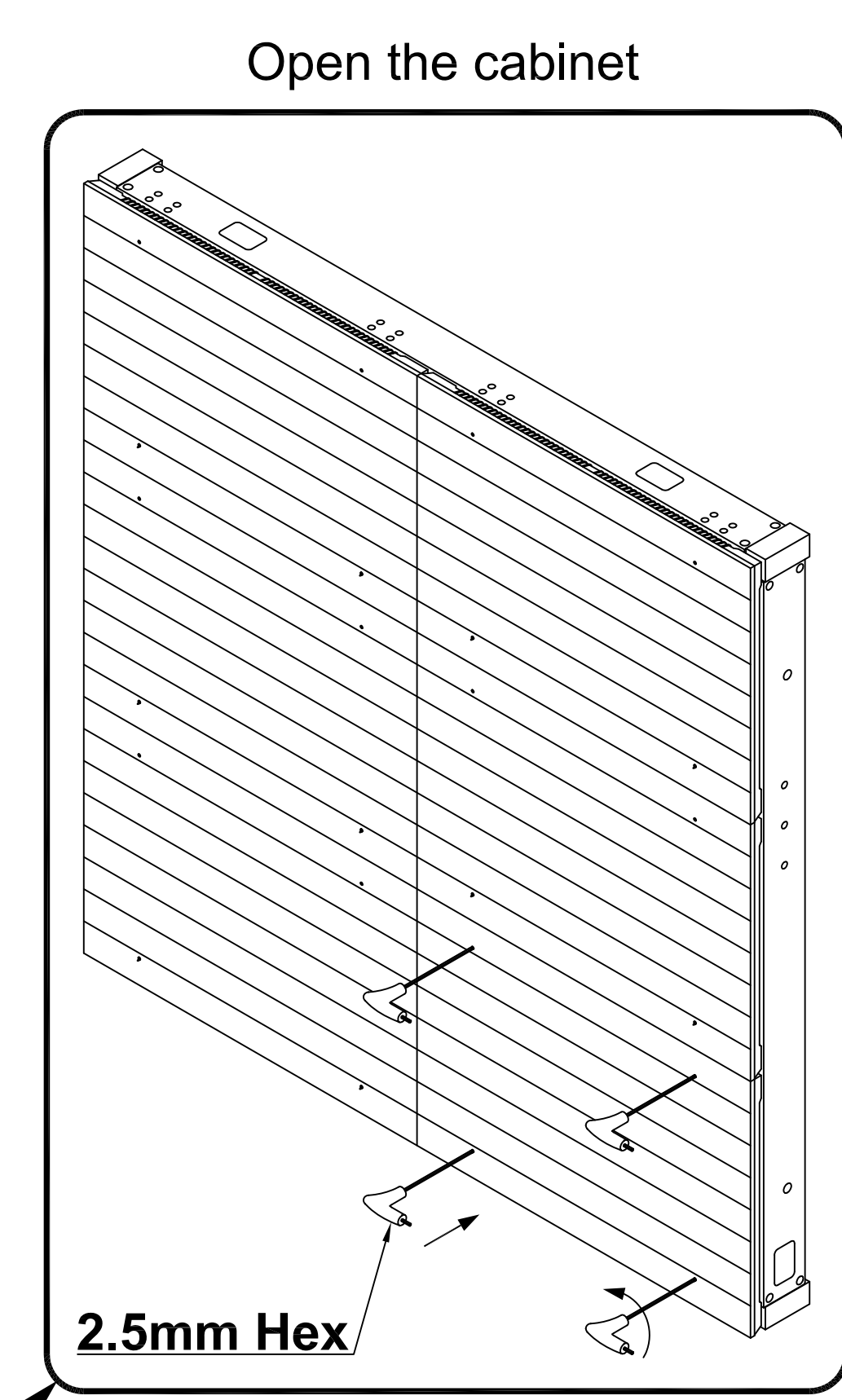
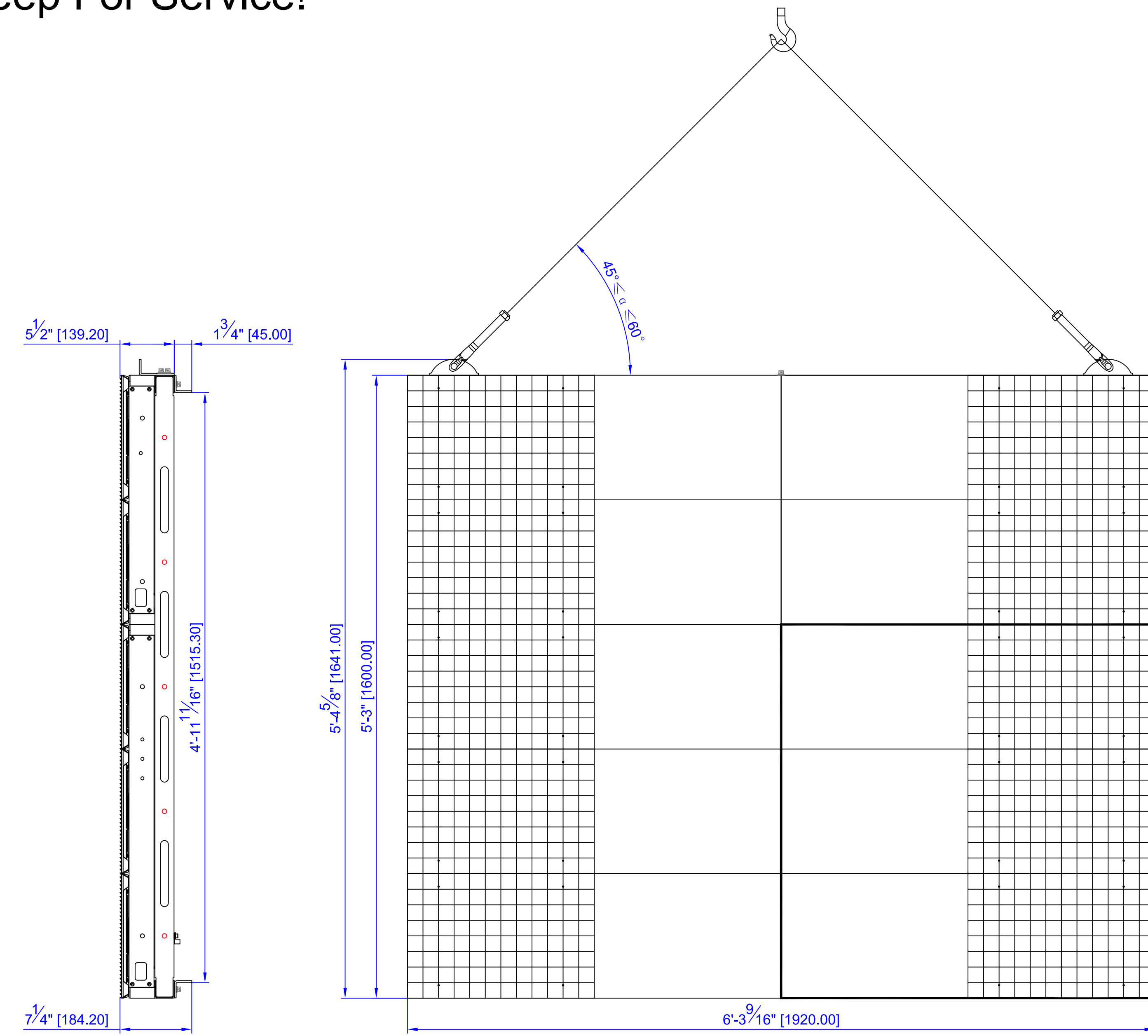

Single Face : 120V 15.4A
 208V 8.9A
 Double Faces : 120V 30.8A
 208V 17.8A

NET CABLE 5E